



SPEED OVEN

# Prática

SPEED OVEN

## ROCKET EXPRESS



INSTALLATION AND OPERATION MANUAL



## **LETTER TO CUSTOMERS**

Pratica Inc. is proud to become part of your day-to-day lives with our products. By purchasing Pratica's equipments, yyou will have a partner always attentive to your needs and interested in keeping customers satisfied.

We are available to serve you at any time, whether it is to hear your ideas, criticisms, suggestions or to solve an issue.

**Count on us!**

### **Our Mission**

Bring quality and productivity to the food preparation environment.

### **Our Commitment**

- To know and meet the needs of our customers.
- Offer reliable, high-performance, and energy-efficient products.
- Always looking for improvements of processes, products and cost to offer more value to our customers every single day.
- Treat our customers with complete honesty and respect.
- Prática Inc. donates a portion of its profit to charitable causes.

*This manual contains all the information for you to install and use your equipment correctly and get the best performance results, with quality and safety.*

*We recommend you to read and follow all the guidelines contained therein and the always keep it in a suitable place for future consultations.*



## SUMMARY

### IMPORTANT SAFETY INSTRUCTIONS

Use Recommendations.....	08
Restrictions of use.....	11
General recommendations for cleaning.....	12
Safety risk: cleaning chemicals.....	12
Safety risk: heating.....	12
Safety risk: electric power.....	13
Suitable utensils.....	14
Combination of suitable utensils.....	14

### PRECAUTIONS TO AVOID POSSIBLE EXPOSURE TO EXCESSIVE MICROWAVE ENERGY.....

15

### IDENTIFICATION OF SYMBOLS USED IN THIS MANUAL.....

16

### WARRANTY TERM

Terms and detailing.....	17
Warranty exclusions.....	17
Notes and recommendations.....	18

### INSTALLATION INSTRUCTIONS

Electrical installation.....	20
General instructions.....	21
Dimensions.....	22
General recommendations.....	23

### ROCKET EXPRESS TECHNOLOGY.....

24

### PRINCIPLES OF OPERATION.....

25

### RECIPES CREATION.....

27

### OPERATING INSTRUCTIONS

Preheating.....	28
Executing a recipe.....	29
Accessing options.....	32
User settings.....	33
• <i>Edit groups</i> .....	34
• <i>Edit name</i> .....	35
• <i>Edit group image</i> .....	36
• <i>Deleting group recipes</i> .....	37
• <i>Delete group</i> .....	38
• <i>Order - group</i> .....	39

## **OPERATING INSTRUCTIONS**

• <i>Change group temperature</i> .....	40
• <i>Edit recipes</i> .....	40
• <i>Edit recipe name</i> .....	42
• <i>Edit recipe image</i> .....	43
• <i>Edit steps</i> .....	44
• <i>Deleting recipe</i> .....	47
• <i>Order - recipes</i> .....	48
• <i>Edit Cook/Brown more</i> .....	49
• <i>Add/Remove favorites</i> .....	50
• <i>Preheat</i> .....	52
• <i>USB</i> .....	53
• <i>Current temperature</i> .....	54
• <i>Celsius/Fahrenheit</i> .....	54
• <i>Wi-fi</i> .....	55
• <i>Web app (IOK - Internet of kitchen)</i> .....	57
• <i>System update</i> .....	58
• <i>Tech support</i> .....	60

## **System.....61**

• <i>Language</i> .....	61
• <i>Date/Time adjustment</i> .....	62
• <i>Volume</i> .....	63
• <i>Change password</i> .....	63
• <i>Restore factory settings</i> .....	64
• <i>Edit access</i> .....	64
• <i>Manufacturer's information</i> .....	65

Favorites.....	65
----------------	----

Sound alarms.....	66
-------------------	----

Manual mode.....	67
------------------	----

## **CLEANING**

Daily procedure guide.....	70
----------------------------	----

Catalytic converter cleaning guide.....	74
---	----

Air filter cleaning guide.....	74
--------------------------------	----

## **ALERTS AND ERRORS: POSSIBLE SOLUTIONS**

Alerts.....	75
-------------	----

Errors.....	76
-------------	----

Alerts and errors table.....	77
------------------------------	----



# IMPORTANT SAFETY INSTRUCTIONS

## USE RECOMMENDATIONS

- Oven operation: It is recommended that the oven operator to always wear thermal protection gloves and an apron (PPE's) to prevent burns when in contact with the oven chamber and possible spillage of the contents of the trays.
- Use of the panel: The panel must be operated with fingers only, the use of any instrument may damage the equipment and jeopardize the operator's safety.

**CAUTION:** To avoid burns, do not use containers with liquids or kitchen products that become liquids by heating up to a boiling point. **The oven must be mounted after the installation at 63in / 5ft / 1.6m above floor level.**



- **WARNING: The lack of kiln cleaning can cause surface deterioration and this can adversely affect the life of the appliance and possibly result in a dangerous situation.**
- Remove metal or plastic sealing wires of bags inserted in the unit. Check if the container used is under specification for temperature and microwaves provided by the unit. Do not use plastic utensils.
- Do not allow children to use or operate this equipment.
- Do not use the equipment if it is damaged, specially if its door is not closing properly.
- Do not place any object between the inner cavity and the oven door, obstructing the door from closing.
- Do not let the power cord hang over the edge of the table or counter.
- Only qualified personnel should open the equipment panel.
- Do not use plastic utensils.
- Do not use water jet for cleaning.
- Do not use steam cleaner for cleaning.
- Do not use the Microwave function without food as it can damage the equipment.



- Do not operate the equipment with the door open due to microwave energy exposure.
- Do not allow food residue or other debris to accumulate on the surface of the door and hinge to avoid damaging the equipment.
- Foods with skin, bark or membrane, such as tomato, potato, sausage, must be perforated with a fork as they may explode.
- Fully sealed packages should not be heated in the oven as they can explode.
- Do not cover or block any air vents on unit.
- Do not use the equipment outdoors or without coverage.
- Do not use this product near water such as near the kitchen sink, in a wet basement, or near a swimming pool.
- Do not use a water jet for cleaning the unit. Please see cleaning instructions for proper cleaning.
- When cleaning the oven surfaces use only non-abrasive products applied with a nylon sponge or soft cloth (**page 70**). **Note: Consult Prática to make sure the correct cleaning product is being used.**
- To reduce the risk of fire in the oven cavity: remove wires used to seal paper or plastic bags that will be into the oven.
- Carefully monitor the equipment when materials such as paper, plastic, and other combustible materials are placed inside the oven for easy cooking.
- Remove all contents located inside the oven cavity.
- If the product catches fire inside the cook cavity, close the door immediately and turn the unit off or unplug it. The power can also be turned off at the circuit breaker.
- Always wear thermal gloves or use holders or tongs to remove the food from inside the equipment to avoid burns.

- Do not use the cavity of the equipment for storage.
- When heating liquids using microwave only or combined function, the contents should be stirred before heating to help prevent eruptive boiling. In microwave beverage heating can result in delayed eruption, so care should be taken when handling the container.
- Liquids, such as water, coffee, or tea are able to be overheated beyond the boiling point without appearing to be boiling. Visible bubbling or boiling when the container is removed from the microwave oven is not always present. THIS COULD RESULT IN VERY HOT LIQUIDS SUDDENLY BOILING OVER WHEN THE CONTAINER IS DISTURBED OR A UTENSIL IS INSERTED INTO THE LIQUID.
- The minimum height of free space above the microwave should be of 5.9in (150mm).
- Only use utensils suitable for use in microwave ovens.
- When heating food in microwave safe container, check the oven frequently due to the possibility of ignition.
- The oven should be cleaned daily and any food remains must be removed.
- Failure to maintain the oven in a clean condition may lead to deterioration of the surface that could adversely affect the equipment service life and possibly result in the warranty loss.
- Do not operate any heating or cooking appliance beneath this equipment.
- Do not mount unit over or near any portion of a heating or cooking equipment.
- Do not mount over a sink.
- Oversized foods or oversized metal utensils should not be inserted in the oven as they may create a fire or risk of electric shock.
- Do not clean with metal scouring pads. Pieces may burn off the pad and touch electrical parts involving a risk of electric shock.

- Some products such as whole eggs and sealed containers – for example, closed glass jars – are able to explode and should not be heated in this oven.
- Do not use paper appliances when equipment is operated in the toaster mode.
- Do not store any materials, other than manufacturer's recommended accessories in this oven when not in use.
- Do not cover racks or any other part of the oven with metal foil. This will cause overheating of the oven.
- It is necessary to remove and clean the air filter frequently. For more details go to **page 74** of the manual.
- Daily cleaning is required to remove fat grease from equipment. For more details, see **page 70** of the manual.
- Clean Only Parts Listed in Manual. Other than that, please contact the manufacturer for instructions.
- Use this equipment only for the functions described in this manual.

## RESTRICTIONS OF USE

- **WARNING: Do not use corrosive chemicals or vapours in this device. This type of oven is specifically designed to heat, regenerate, gratin or finish food that has already undergone some cooking process. Not suitable for cooking food or products in general. It is not designed for industrial or laboratory use.**
- Use only utensils suitable for use in microwave combo ovens on **page 14**.
- Never use the device to heat alcohol, cognac, rum, etc.
- Alcohol can catch fire more easily if overheated. Be careful and do not leave the device unattended.

- If smoke is observed, turn off the device. Disconnect or isolate it from the power supply and keep the door closed to muffle the flames.

## GENERAL RECOMMENDATIONS FOR CLEANING

- The cooking chamber of the equipment must be cleaned daily. Failure to keep the equipment clean can lead to surface deterioration, which can adversely affect the life of the appliance and possibly result in a hazardous situation.
- The equipment shall be disconnected from the mains during maintenance and replacement of parts. It is not necessary to disconnect the equipment from the power supply during daily cleaning of the equipment.

## SAFETY RISK: CLEANING CHEMICALS

DANGER	WHERE OR IN WHAT SITUATIONS DOES DANGER ARISE?	PREVENTIVE ACTION
Risk of chemical burns or irritation of the skin, eyes and respiratory system due to contact with cleaning chemicals and their fumes.	For all cleaning actions.	<ul style="list-style-type: none"> <li>• Do not let cleaning chemicals come into contact with your skin or eyes.</li> <li>• Do not heat the appliance if there are cleaning chemicals inside.</li> <li>• Don't breathe in the chemical spray.</li> <li>• Use personal protective equipment (PPE's).</li> </ul>
	When corrosive cleaning chemicals are used.	<ul style="list-style-type: none"> <li>• Strictly follow the steps to cleaning page 70.</li> </ul>

## SAFETY RISK: HEATING

DANGER	WHERE OR IN WHAT SITUATIONS DOES DANGER ARISE?	PREVENTIVE ACTION
Risk of burns from hot surfaces.	Inside the entire cavity, including all parts that are or have been inside during cooking, such as: <ul style="list-style-type: none"> <li>• Racks;</li> <li>• Containers;</li> <li>• Baking sheets.</li> </ul>	<ul style="list-style-type: none"> <li>• Before starting cleaning tasks, wait until the cavity has cooled below 50°C (122°F).</li> </ul>
	Inside the equipment door.	Wear personal protective clothing and equipment (PPE's) as shown on page 08.

• **SAFETY RISK: ELECTRIC POWER**

DANGER	WHERE OR IN WHAT SITUATIONS DOES DANGER ARISE?	PREVENTIVE ACTION
Risk of electric shock by energized parts.	<ul style="list-style-type: none"> <li>• Under the covers;</li> <li>• on the operating panel;</li> <li>• Along the power cord.</li> </ul>	<ul style="list-style-type: none"> <li>• Work on the electrical system must be performed only by qualified electricians of an authorized service company.</li> <li>• Professional Work.</li> <li>• Make sure that all electrical connections are in perfect condition and securely fixed before putting the equipment into use.</li> </ul>
	In the equipment and adjacent metal parts.	<ul style="list-style-type: none"> <li>• Before preparing the equipment for use, make sure that the equipment is connected to a equipotential compensation system (UE).</li> </ul>
	If the equipments on wheeled supports start to move accidentally and the power supply is switched off.	<ul style="list-style-type: none"> <li>• When operating the equipments, always engage the safety lock on the wheels.</li> <li>• Check daily that the wheel locks are activated before starting the operation.</li> </ul>
Risk of electrical shock caused by a short circuit.	If the equipment comes into contact with water.	<ul style="list-style-type: none"> <li>• Do not wash the outer box with water.</li> <li>• Always keep the USB cover closed while cleaning.</li> </ul>

## SUITABLE UTENSILS

Check the manufacturer's instructions and temperature rating to determine the suitability of individual containers and accessories to be used with the furnace. The table below provides general guidelines:

SUITABLE KITCHEN UTENSILS	ALLOWED	PREVENTIVE ACTION
<b>HEAT-RESISTANT CONTAINERS</b>		
Tempered glass.	<b>YES</b>	
Compatible ceramics.		Do not use items with metallic decoration.
Earthenware (crockery, porcelain, etc.) Note: the level of mineral load present in the utensil can affect the performance of the equipment		
<b>METAL AND FOIL TRAYS</b>		
Any metal or foil containers	<b>NO</b>	
<b>PLASTIC CONTAINERS</b>		
Plastic containers	<b>NO</b>	
<b>DISPOSABLE</b>		
Fuels (paper, cardboard, etc.)	<b>YES</b>	Use only disposables compatible with the temperatures reached by the oven (280°C).
<b>OTHER UTENSILS</b>		
Tethers and labels	<b>NO</b>	During the cooking process no utensil such as probes, cutlery, straps and labels must be inside the oven.
Cutlery		
Temperature probes		

## COMBINATION OF SUITABLE UTENSILS

COMBINATION OF ACCESSORIES	ALLOWED	OCCURRENCE
Panini Style Grill Plate	<b>YES</b>	
Panini Style Grill Plate + Solid PTFE Basket	<b>YES</b>	
Panini Style Grill Plate + Aluminum Pan	<b>NO</b>	It affects the performance of the equipment and can damage the microwave system.
Aluminum Pan	<b>YES</b>	
Aluminum Pan + Solid PTFE Basket	<b>NO</b>	It affects the performance of the equipment, can damage the microwave system and can damage the teflón basket.
Teflón accessories	<b>YES</b>	

## USE RECOMMENDATIONS (continuation)

### CAUTION!

- The equipment is not intended for use by people (including children) with reduced physical, sensory or mental capabilities, or that have not been properly trained to operate the unit.



- Do not use the oven handle to move the equipment. The oven must be moved exclusively from its sides.



- Do not use the equipment door as support. It will cause unevenness of the door and equipment malfunction.



- The oven door is only intended for sealing microwaves generated during cooking. Using the door for any other purpose not described in this manual may void the warranty.

### PRECAUTIONS TO AVOID POSSIBLE EXPOSURE TO EXCESSIVE MICROWAVE ENERGY

- (a) Do not attempt to operate this oven with the door open since open-door operation can result in harmful exposure to microwave energy. It is important not to defeat or tamper the safety interlocks.
- (b) Do not place any object between the oven front face and the door or allow soil or cleaner residue to accumulate on sealing surfaces.
- (c) Do not operate the oven if it is damaged. It is particularly important that the oven door close properly and that there is no damage to the: (1) Door (bent), (2) Hinges and latches (broken or loosened), (3) Door seals and sealing surfaces.
- (d) The oven should not be adjusted or repaired by anyone except properly qualified service personnel.

## IDENTIFICATION OF SYMBOLS USED IN THIS MANUAL



**DANGER!** THREAT OF RISK THAT MAY CAUSE SERIOUS INJURY OR DEATH



**ALERT**



**WARNING - FIRE RISK** - TO REDUCE THE FIRE RISK DO NOT REMOVE THIS COVER. NO USER-SERVICEABLE PARTS INSIDE. REPAIR SHOULD BE DONE BY AUTHORIZED SERVICE PERSONNEL ONLY



**MICROWAVE WARNING SYMBOL:** THIS SYMBOL IDENTIFIES THERE IS A RISK OF EXTERNAL AND INTERNAL BURNS OF BODY PARTS FOLLOWING EXPOSURE TO MICROWAVE ENERGY.



**WARNING - RISK OF ELECTRIC SHOCK** - TO REDUCE THE RISK OF ELECTRIC SHOCK DO NOT REMOVE THIS COVER. NO USER-SERVICEABLE PARTS INSIDE. REPAIR SHOULD BE DONE BY AUTHORIZED SERVICE PERSONNEL ONLY



**WARNING - BURN RISK** - DO NOT TOUCH ANY PART WITH THIS SYMBOL WHILE THE OVEN IS IN OPERATION.



**WARNING - RISK OF BURN FROM SPILLING OF HOT LOAD** - TO AVOID BURNS, DO NOT USE CONTAINERS WITH LIQUIDS OR KITCHEN PRODUCTS THAT BECOME LIQUIDS BY HEATING UP TO A BOILING POINT.



**GROUNDING SYMBOL**



**EQUIPOTENTIAL SYMBOL**



**USE TIPS AND INFORMATION**



## **WARRANTY TERM**

### **TERMS AND DETAILING**

- a)** Our products are warranted for twelve 12 months for parts and labor, and twenty-four months for the all heating element parts; from the date the product is installed. If, for any reason, there is no record of the installation date nor the purchase invoice is not found, the date of manufacture of the equipment contained on the indicative label will be considered the date of beginning of the applicability of this guarantee.
- b)** If new visits are needed to complete the delivery/installation of the product due to the lack of adequate, electrical, or exhaust related conditions, the costs of such visits shall be the customer's responsibility.
- c)** For the appliance's installation, the customer must provide all conditions required (208v/240v single phase) in the installation blueprint. The customer will also be responsible for transporting the equipment to the installation site.
- d)** The warranty only covers manufacturing and component failures, damages caused by lack of heeding label warnings on the product will not be covered.
- e)** The warranty will cover adjustments and replacement of defective parts. It is the responsibility of the authorized service technician to return the defective parts to Pratica Inc. for analysis when requested by the Manufacturer.
- f)** Warranty service calls will not justify the extent of the warranty, returns or exchanges of the equipment, or any other type of claim.

### **WARRANTY EXCLUSIONS**

- a)** The customer should thoroughly inspect the equipment upon delivery and contact the carrier in case of shipping damage arising from transport.
- b)** Prática will not respond for any issues arising for electrical building irregularities, or a lack of abiding to the local electrical code.
- c)** Use or installation not in accordance with the Installation and Operation Manual accompanying the product.

- d)** Failure to observe the installation details per the Installation and Operation Manual, such as uneven floors, installing the oven next to equipment that exudes fat, heat or solid particles, lack of air circulation, etc.
- e)** Any damage and defects resulting from inappropriate cleaning products that result in damages to the components will not be covered under warranty. For example, pouring water inside the electric panel, etc.
- f)** Changes performed by unauthorized technicians in the original conditions of installation such as electrical distribution, installation location, etc.
- g)** Use of aggressive or abrasive products that are unsuitable for cleaning which may tarnish, wear, scratch or damage accessories or equipment components.
- h)** Occurrences from electrical discharges arising from acts of nature or voltage peaks caused by generators or power supply companies.
- i)** Damage to the equipment or its accessories caused by accidents, improper operation, improper handling or installation as described by the Operation Manual included with this product.
- j)** Repair attempts by unauthorized third parties or use of non-OEM parts and components, regardless of the damage or defects.

## **NOTES AND RECOMMENDATIONS**

- a)** The operator should use the Installation and Operation Manual as a guide.
- b)** Make sure that the electric systems are made and installed by a qualified company or technician.
- c)** Before contacting technical assistance, check the manual for troubleshooting tips that can be solved without a technician. Always remember that Pratica must be contacted first before getting in contact to with a service agent.

d) You can call our technical assistance to provide feedback, suggestions, or get assistance troubleshooting during normal business hours at +1 214 584-6269 or +1 469-583-4643.

### EQUIPMENT IDENTIFICATION

*(Fill in to make technical support calls easier)*

MODEL			
VOLTAGE		SERIAL NUMBER	
RESELLER			
INVOICE NUMBER		PURCHASE DATE	

# INSTALLATION INSTRUCTIONS

## ELECTRICAL INSTALLATION

- Always follow the installation instructions in the instruction manual or the product's spec sheet. This form is attached to the manual, in addition to being sent by email upon approval of the order, it is also available on our website ([www.praticabr.com](http://www.praticabr.com)), in case of questions, contact Prática Technical Assistance: **+55 35 3449-1235** (All world) or **214-584-6269** (Only for United States and Canada).
- The installation of the Prática ovens must be done with the necessary care to avoid problems, damage to the equipment, and guarantee its full use.
- This equipment must be installed by an authorized technician.



- The equipment **MUST** be grounded.
- The oven must have a exclusive circuit breaker.
- Do not immerse the power cable or connect water to the unit.
- Keep the power cord away from heated surfaces.



- If the power cable is damaged, it must be immediately replaced by an authorized technician to avoid shock hazards.
- Only qualified personnel should open the equipment panel.
- There is an equipotential point on the rear panel of the oven.

Region	Voltage (V)	Phases	Freq. (Hz)	Power (kW)	Circuit Breaker (A)	Cable	Socket
USA	208	Single	60	6.2	32	3x10AWG	NEMA 6-30
	240			7.2			
Europe	230	Single	50	6.9	32	3x4mm <sup>2</sup>	32A (2P+E)
	230	Multi	50	6.9	32	5x2,5mm <sup>2</sup>	32A (4P+E)
	380	Multi	50	6.6	16	5x2,5mm <sup>2</sup>	16A (3P+N+E)
	400	Multi	50	6.9	16	5x2,5mm <sup>2</sup>	16A (3P+N+E)

# INSTALLATION INSTRUCTIONS

**Note:** The equipment has a connector for interconnect it with other equipment. This connector is intended to keep several devices with the same electrical potential. Not necessarily the grounding of a local connection. This connector on the back of the device is identified by the symbol on the right:

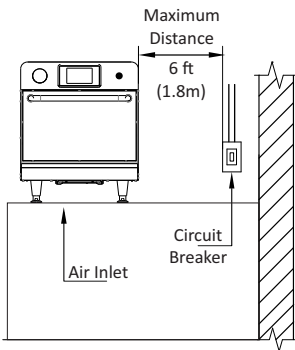

- Use of pressure cables to prevent movement of the power cable.
- In case the oven voltage is 380 volts, a neutral cable (independent of the ground) must be available.
- Ensure that the electrical characteristics of the power grid are in accordance with the technical specifications located on the identification tag label located on front bottom cover of the unit. The power grid is a customer's responsibility.
- This unit must be properly grounded to avoid electrical shock .
- The circuit braker should be located no more than 70,8in / 6ft / 1.8m away from the unit.

## GENERAL INSTRUCTIONS

- The oven must be installed on a surface or counter that supports its weight of approximately 194lb (88 Kg).
- Do not obstruct the air inlets and outlets at the oven bottom.
- The oven must not be positioned near stoves, deep fryers, hot plates and other equipment that releases fat, fumes and heat. The ventilation, electrical panel and motor vents must be far from these heat sources to prevent damage to the electrical system of the equipment.
- The oven must be installed in a leveled and well-ventilated area.
- The installation of the equipment in a non-suitable place can result in the warranty loss.

# INSTALLATION INSTRUCTIONS

## DIMENSIONS

### ROCKET EXPRESS

FRONT VIEW

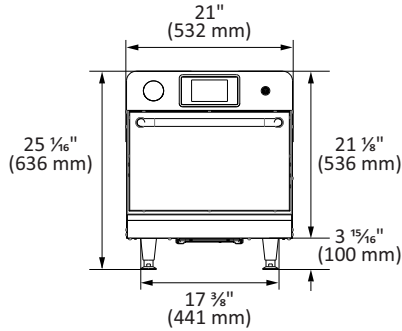

SIDE VIEW

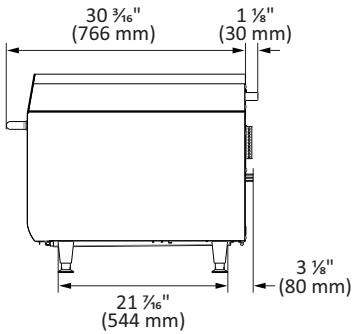

SIDE VIEW  
WITH DOOR OPEN

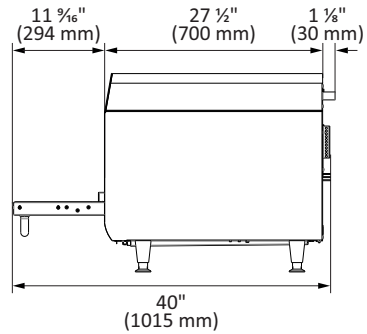

Chamber Dimension	
Capacity	21L - 0.74 cu.ft
Height	5 3/4" - 146 mm
Width	15 1/2" - 394 mm
Depth	14 1/4" - 362 mm

## GENERAL RECOMMENDATIONS



- Do not use this product near water, kitchen sink, wet places, or near a swimming pool.



- If a residue accumulation inside the chamber catches fire, keep the oven door closed, turn the equipment off and unplug it from the power outlet.



- Do not use the oven to dry or to store clothes.



- If the oven door is damaged, it must not be operated until it gets repaired by a qualified technician.

- In case of voltage loss or error during a recipe, the progress will be lost. Recipes will keep intact if the issue regarding power grid.
- Do not cover or block any air inlet and outlet of the unit.
- Do not use the oven outdoors.
- Do not store food inside the oven when it is not in operation.
- When enabling the oven circuit breaker, wait ten (10) seconds before turning it on.

## ROCKET EXPRESS TECHNOLOGY

The **Rocket Express** oven uses a combination of heating for high-speed forced air convection and microwave energy to heat forced food more quickly than the conventional methods.

*The figure below illustrates the steps involving the technology:*

- 1 - Internal heating elements transfer thermal energy to the circulating air.
- 2 - The blower motor circulates air at high speed and envelops the food.
- 3 - The circulating air goes through the catalyst where the grease laden vapors are broken down.
- 4 - The bottom heater helps the heat transfer within the chamber.
- 5 - At the same time, Magnetrons generate energy via microwave that evenly heats the food water molecules.

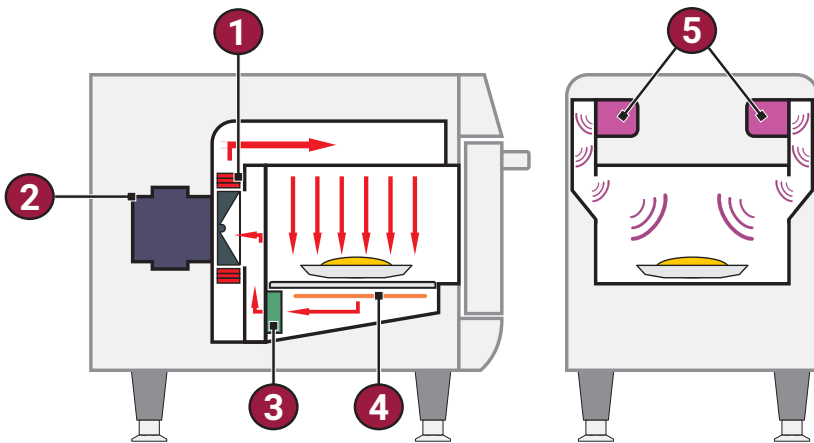



## PRINCIPLES OF OPERATION

Microwaves are a type of radiation energy. Just like radio waves, visible light and infrared, the microwaves are part of the electromagnetic spectrum, i.e., it is a form of electromagnetic radiation. They are classified as non-ionizing radiation, because, unlike x-rays, Alpha, Beta and Gamma rays, its effects are strictly thermal and therefore do not alter the molecular structure of the item that is being irradiated.

The basic principle of microwaves is to cook by molecular vibration. They penetrate the food surface in a depth that ranges from two to seven centimeters, heating the molecules of water and fat by making them vibrate. The heat is transmitted to the interior of the food by thermal conduction, demystifying the idea that the microwaves cook food from the inside out.

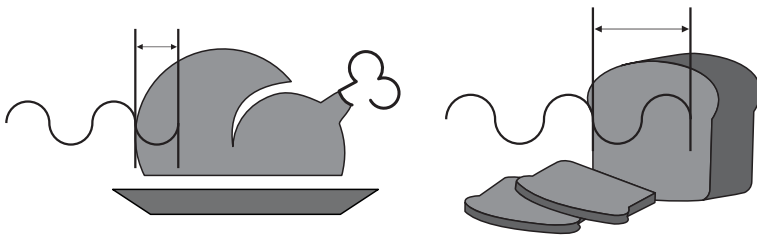

The **Rocket Express** works through the association between microwaves and hot air directed towards the food. The variables in the operation consists of:

- a) *Operation time.*
- b) *Chamber temperature.*
- c) *Microwaves power.*
- d) *Air speed.*

Each recipe operation can be programmed with up to eight steps and each of them can have the variables mentioned above.

**Temperatures:** The preparation times are short and so are the steps. The temperature variation between steps will not be observed by the unit. Normally, the temperature used is the same temperature as the preheating set point.

**Microwaves:** The microwave is adjustable between 0% and 100% for each 30 second fraction. For example, the microwaves in a one-minute recipe with microwave programmed at 50% will run for 15 and stop for 15 seconds. Then it will be energized for another 15 seconds and stop for the remaining 15 seconds. In 1 minute, it will act for a total of 30 seconds.

Microwaves are reflected by metals but will penetrate glass, plastics, and ceramics. The microwaves penetrates the food and generates water molecules friction, heating the food.

## FEATURES

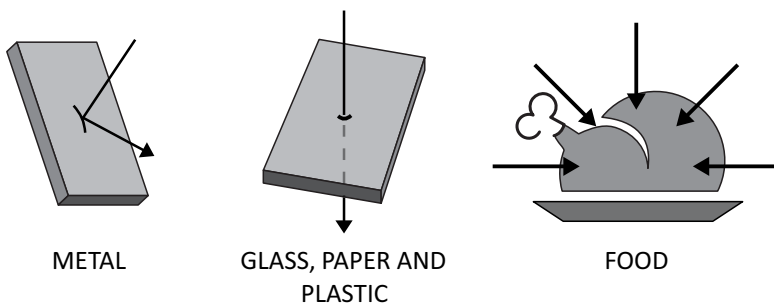

The use of plastic or paper material must respect its specifications since it must support up to 280°C/ 536°F and being microwavable.

**Operation Time:** The food heated by microwaves occur from the outside in and the penetration level will vary depending on the type of food. Therefore, the preparing time has to be related to the meal composition, the quantity of food processed, as well as its density and thickness. The larger the food amount (quantity or density), the greater the time or percentage will be needed for the microwave to take effect.

**Hot Air Speed:** The hot air speed can be adjusted between 0% and 100% of speed. The hot air is controlled by a blower motor which will envelope the food.

a) *The higher the air speed, the more likely it will be to burn the product on its surface.*

b) *The higher the air speed, the more it will affect the texture and crispness of the product.*

## RECIPES CREATION

When creating a recipe, all the variables mentioned earlier should be considered. The microwaves and the air speed are both critical factors for a successful preparation.

To get faster results in the recipe creation, we suggest beginning programming at 1/10 of the total time of preparation used in a conventional process.

The microwave effect is more efficient at the beginning of processes. For frozen products, work with two or three steps, so that at the beginning of the process the product is thawed with lower microwave levels and at the end of the process the colour and crispness are obtained.

Later, combine the air speed variations to reach the desired crispness and color. Remember, the air also transmits heat to the food so keep that in mind when setting blower percentage. The food's weight, size, and shape are critical when setting the total cook time.

### **The following information is critical when creating a new recipe:**

- a) The initial temperature of the product will change the desired results if the following conditions are not considered: preheating and meal condition (refrigerated, frozen or in room temperature)*
- b) The size and/or weight variation of the meal has to be considered when programming a standard recipe.*
- c) Only use containers approved for a microwave oven to prevent any damage and that the product gets properly cooked.*

## OPERATION

*After initialization, choose your preferred language. See more about languages on page 61.*

## PREHEATING

a) To start the oven preheating process, after turning on the equipment, choose between Preheating Temperature 1 and Preheating Temperature 2.

b) The following screen will present the CURRENT, PROGRAMMED temperature and the bar indicating the remaining time to utilize the equipment.

**Note:** *The timer is only initiated when the CURRENT temperature reaches to the PROGRAMMED; that occurs so that the oven temperature enters in uniformity throughout the chamber.*

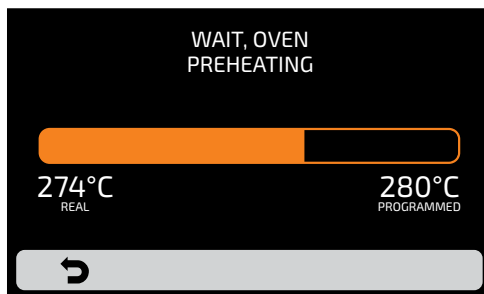
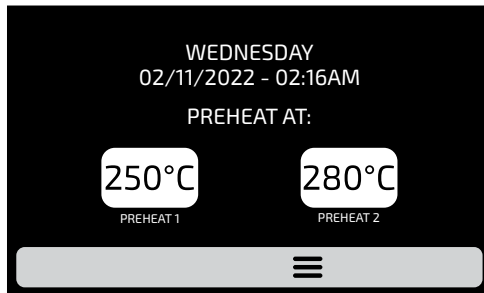

## EXECUTING A RECIPE



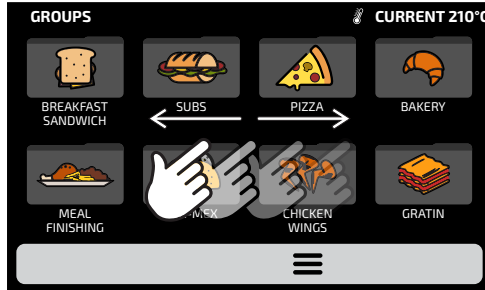

**WARNING:** FOR THE FOLLOWING INSTRUCTIONS TO BE VALID IT IS NECESSARY TO PROGRAM RECIPES OR UPLOAD A PRESCRIPTION BEFORE.

a) After the preheating, select the Group icon desired. Slide  the screens to the left and right in order to transit between the group screens.

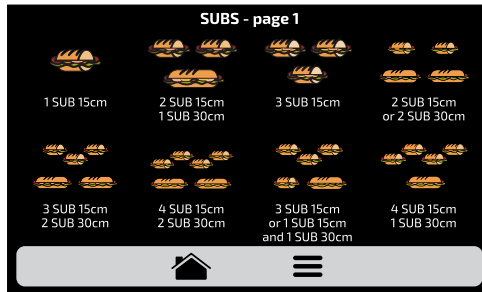

b) The RECIPES of the selected group will be displayed, select the recipe desired.



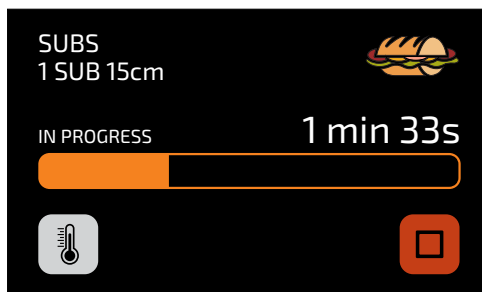

- To return to the GROUPS screen, push the button: .
- To access the next recipes page, slide  for right the screen and for the left to return.
- **Note:** Before starting a recipe, make sure there is food inside of the cook cavity, otherwise it may cause damages to the unit.

c) The recipe will enter in execution immediately.



- The screen will present the group name, recipe name, operation status (In progress or paused), and the remaining time for conclusion of the recipe.

d) It is possible to verify the temperature of the **TOP HEATER** and of the **BOTTOM HEATER** pressing the  button.

e) In case you wish to cancel the execution of a recipe, push the  button.

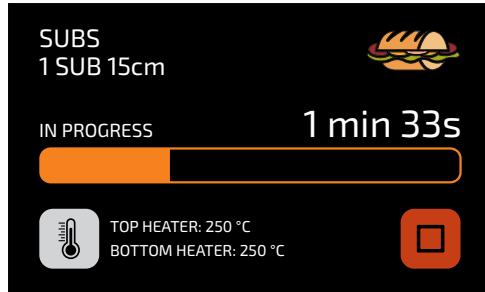

e) If the equipment door is opened, the operation will be paused; once the door is closed again, press the  to resume the operation.

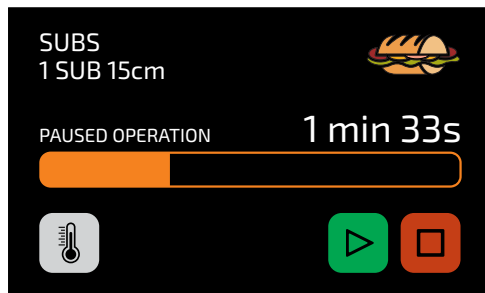

f) If the Operator desires to add an information between steps, for example: 'ADD TOMATOES', the recipe will be paused and the description of the information will be presented beside the PLAY button, as in the next image:

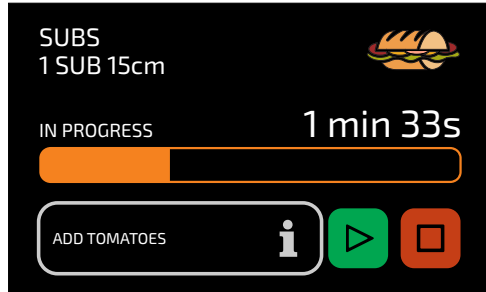

g) Press the  button to resume the operation.

h) At the recipe's end the following options will be presented:



**Cook/Brown More:** Activates the microwave and hot air during a predetermined time.



**Brown More:** Activates only the hot air during a predetermined time.



**Cook More:** Activates only the microwave during a predetermined time.



**Repeat Recipe:** Repeats the same recipe chosen by the user.

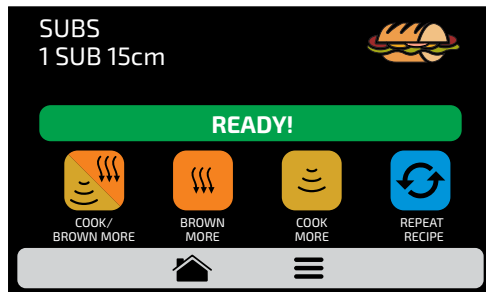

i) In 'Cook/Brown More', 'Brown More' and 'Cook More', the time will be defined at the moment of creating the recipe.

j) The four options mentioned above may be disabled so that they do not appear in any recipe. Learn more in the User's Settings: Edit Accesses (**see page 64**).

### "Heat more" exemple:

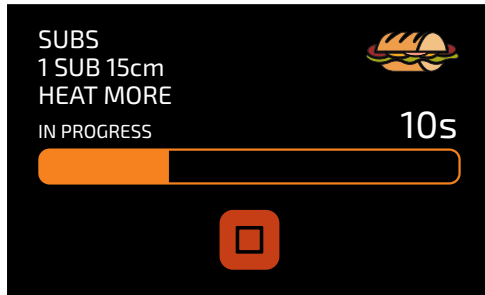



## ACCESSING THE OPTIONS

a) To access the settings, at any time, touch on the icon  found in the fixed menu bar.

b) In the Options Screen, there will be information such as: Current temperature in the Chamber, Favorites ([see page 65](#)), Manual Mode ([see page 67](#)), Daily Procedure Guide ([see page 70](#)) and Settings ([below](#)).

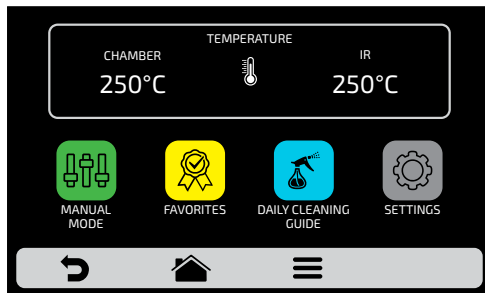
**Note:** Manual Mode and Favorites will only be shown if enabled by the administrator ([see page 64](#)).



c) Touching on the icon  once more will return to Groups Screen.

d) Touching on the icon  will return to the Preheating Temperature selection screen.



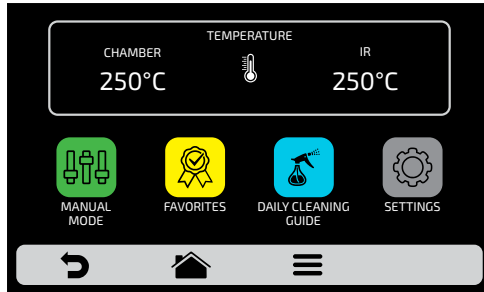

## USER'S SETTINGS

a) Inside the Options Screen, click on the icon  on the screen to inform the User's Password that will be presented.

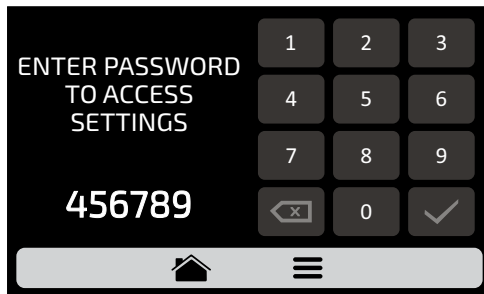

b) The standard password for the user settings is 456789. The password may be changed (see page 63).



c) The User Settings screen is composed by eleven items. Use the gridview, sliding  on the touch screen to access the next options screen. Understand each item in detail in the following pages.

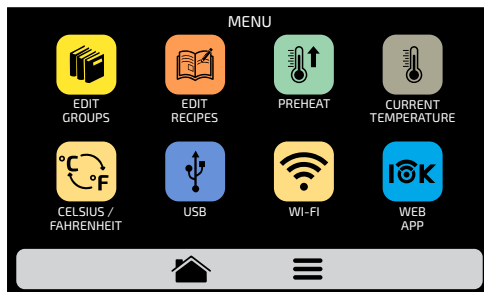

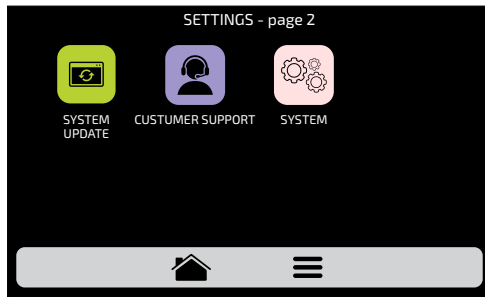

## USER'S SETTINGS: EDIT GROUPS

**Note:** The kiln has two preheating temperatures as shown on **page 28**. After pre-heating, the oven will show the recipes for the selected pre-heating group. Recipes set in Group 1 will only be available when Preheating 1 is executed and the same applies to Group 2.

a) To edit the recipes groups, touch on the  icon, the groups screen will be presented. However, in the first position will be the icon in which it is possible to Create New Group.



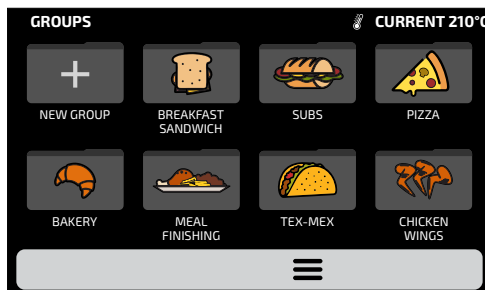

b) Choose between creating a new group, or select the group you desire to edit. Slide  the screens to the left and right in order to transit between the group screens.



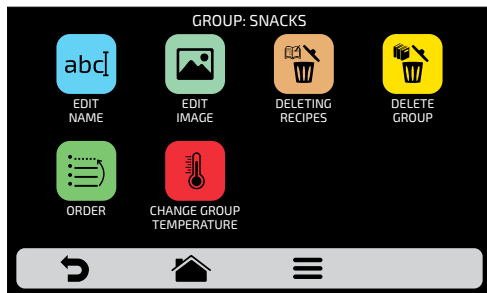

c) The available options after choosing between editing or creating a group will be:





 **Edit Name:** changes the group's name, It is possible to use letters, numbers or special characters.

 **Edit Image:** changes the images of the group icon.

 **Delete Group:** deletes all the information of the selected group, including the recipes.

 **Delete Recipes:** deletes a selected recipe.

 **Order:** orders the location desired for a selected group.

 **Change Group Temperature:** changes the group preheating temperature. **Note:** Recipes set in group 1 will only be available when running Preheating 1 and the same applies to group 2.



## EDIT NAME

a) By selecting the Edit Name option, the following screen will be presented:



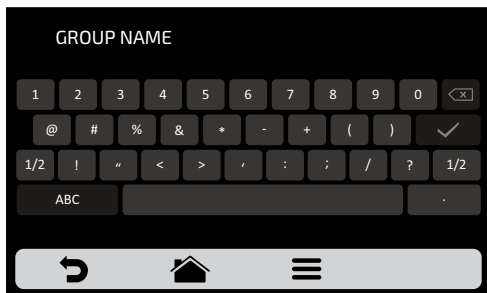

b) Clicking on **&123** and **ABC** (1/2 and 2/2) the screen will swap between letters and numbers/special characters.



	
Deletes a character	Saves the name and returns to the options

## EDIT IMAGE

a) The **Rocket Express** has an icon gallery that enables the user to change groups icons. Press the  icon.

b) A screen with a library of images will be presented, browse through the images and select the image desired. It is also possible, instead of adding an image, to maintain the first letter of the group name as the group icon, just click on the ABC icon. Slide  the screens to the left and right in order to transit between all images.

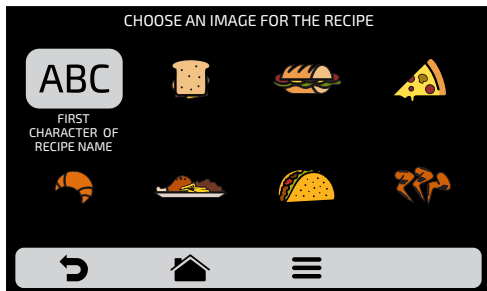



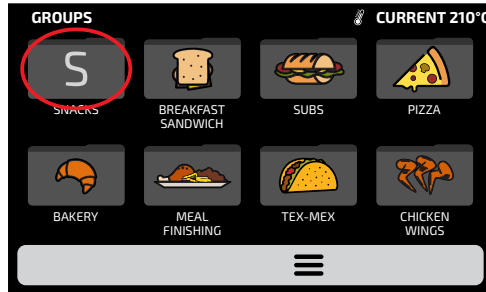

For example: if the group is called SNACKS, on the group screen, Snacks will have the letter 'S' as its icon.

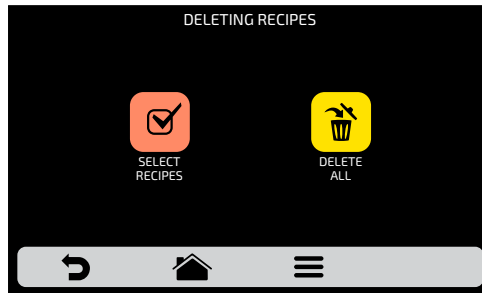

## DELETING RECIPES

a) The deleting recipes option enables the user to delete only the recipes of the previously selected group. Press the button . On the next screen, it will be possible to delete a selection of recipes, or all the recipes:



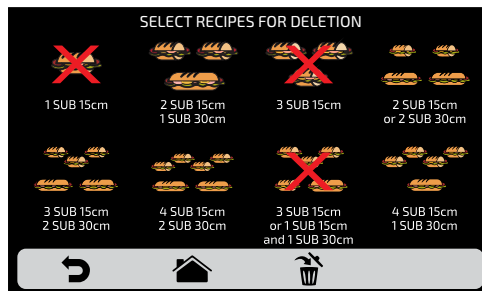

b) Select the recipes  desired recipes to be deleted, the  will indicate the selected ones, and then click on the trash can of the fixed bar .

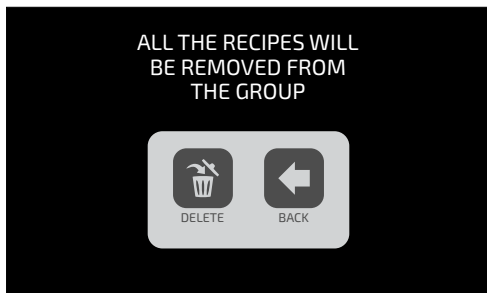

The opposite message will appear - To confirm the exclusion of the recipes, click on the icon 'DELETE SELECTION'; to continue selecting, click on 'CONTINUE SELECTION'.

c) When clicking on the Delete All  icon, the following message will be presented:





To confirm, click on  or, to cancel, and return click on  .

## DELETE GROUP

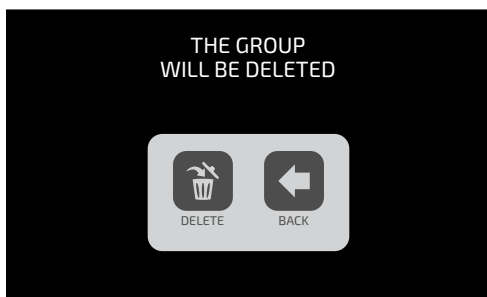
a) **ATTENTION:** When choosing the option of deleting the group, all the information referring to the group will be lost: recipes, steps and other information. And in case the user does not perform a Backup (**see page 53, USB Options**), it will not be possible to recover this information.



b) Press the button  to confirm your choice, or  to return to the options screen.

## ORDER

a) The Order function , enables to change the sequence in which the groups will appear on the groups screen.

*This screen is composed by three options:*





**Place at the list start:** The group is moved to the beginning of the groups list.



**Place at the list end:** The group is moved to the end of the groups list.



**Choose place in the list:** The operator will be directed to the groups screen to choose the location desired.

b) To change the position of a group, just click on the group to select and slide  to the desired position. Press  to save the change.

c) If the substitution is done vertically (1-2, 3-4, 5-6 and 7-8) the two groups in question will change position without changing the order of the other groups, as shown in the image below:

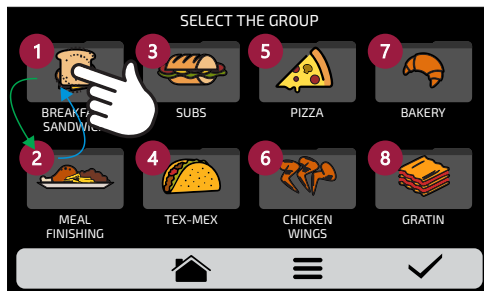

d) If the substitution is done randomly, once the position is selected, the groups will be ordered sequentially (1, 2, 3, 4, 5, 6, 7 and 8), as shown in the image below:

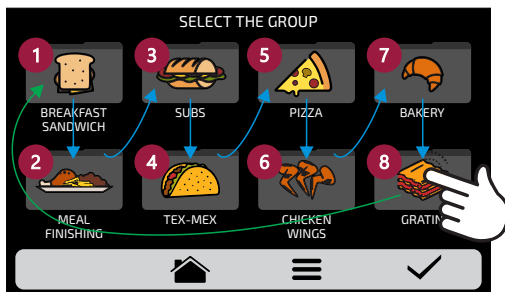



## CHANGE GROUP TEMPERATURE

a) Choose the desired preheating temperature to the selected group .

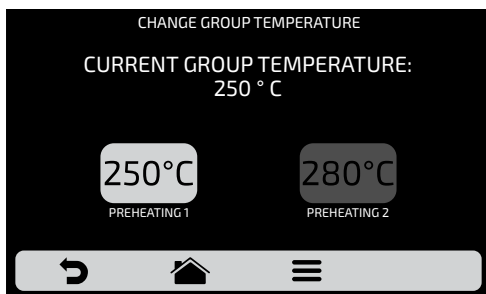
**Note:** Recipes set in group 1 will only be available when running Preheating 1 and the same applies to group 2.



## USER'S SETTINGS: EDIT RECIPES

a) To edit the recipes, click on the icon . The groups screen will be displayed. Choose in which group you wish to change the recipes. Use the gridview, sliding  on the touch screen to see all recipes.

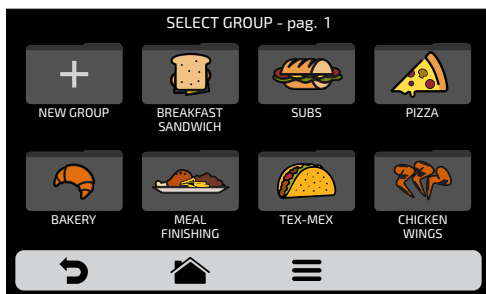





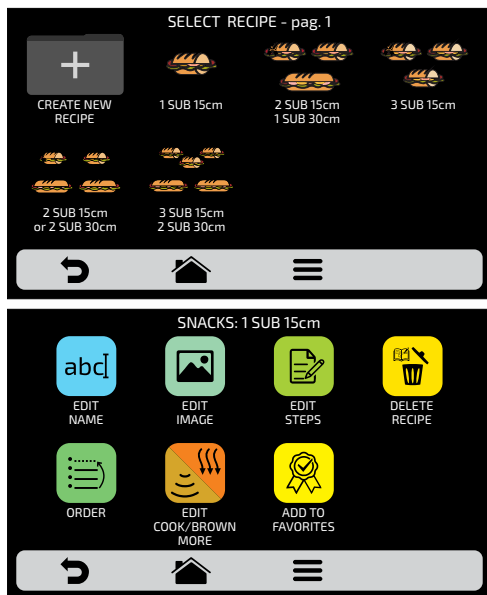



b) When accessing the recipes, it will be possible to edit an already existent one or create a new recipe.



The available options after choosing between editing or creating a recipe will be:

-  **Edit Name:** changes the name of the recipe, you may use letters, numbers or special characters.
-  **Edit Image:** changes the picture or icon of recipes.
-  **Edit Steps:** accesses the options for edition of the steps of the selected recipe.
-  **Delete Recipe:** deletes all the information of the selected recipe, including the steps.
-  **Order:** orders the location in which the recipe appears among the other recipes of the group.
-  **Cook/Brown More:** Changes the time of Cook/ Brown More function.
-  **Add/Remove from Favorites:** Adds or removes the recipe in the Favorites list.



## EDIT NAME

a) When selecting the Edit Name option, the following screen will be presented:



b) Clicking on **&123** and **ABCDE** (1/2 and 2/2) the screen will toggle between letters and numbers/special characters.



	
Deletes a character	Saves the name and returns to the options

## EDIT IMAGE

a) The **Rocket Express** has an image gallery that enables the user to change the icons/picture of the recipes. Click on the icon  to edit and then choose between  **ICONS** or  **PICTURES** for the displayed recipes.

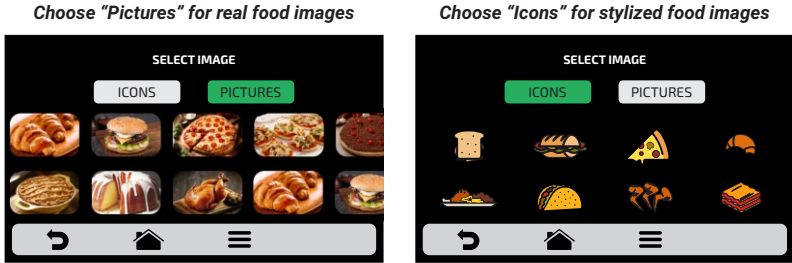

b) To access the next recipes page, use the gridview, sliding  on the touch screen to see all recipes.

c) Browse through the icons of the image library to select the desired icon or press the button  to transform the first letter of the recipe name into an icon, as shown in the adjacent example.

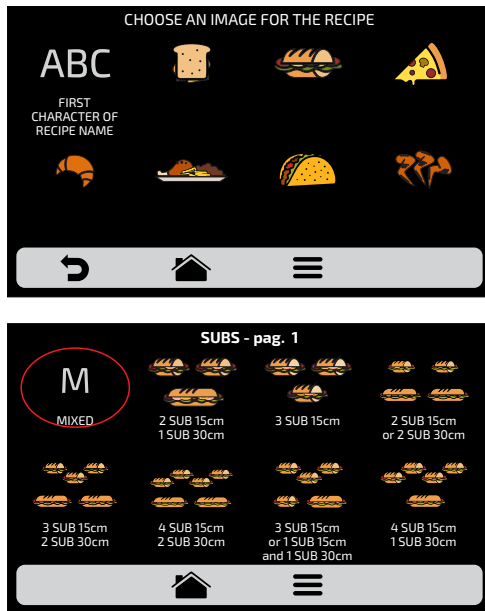

c) Use  to return to the recipe editing options.

## EDIT STEPS

a) Every recipe supports up to 8 steps. The active steps will appear in green on the Edition screen, the other ones will be transparent. Click on a step to edit it.

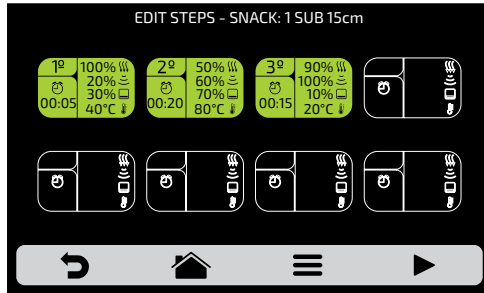

b) For each step, it is necessary to set:

- 1 - Impinged air speed;
- 2 - % of microwaves;
- 3 - % of the bottom heating element wattage;
- 4 - Temperature;
- 5 - Time.

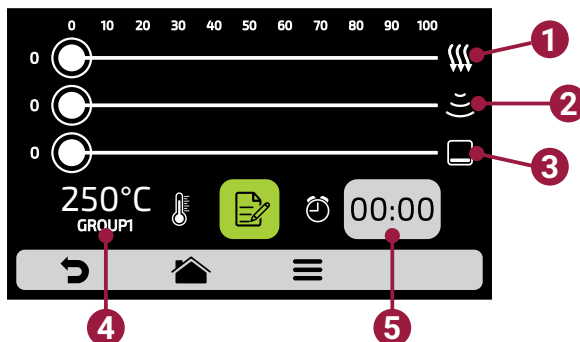

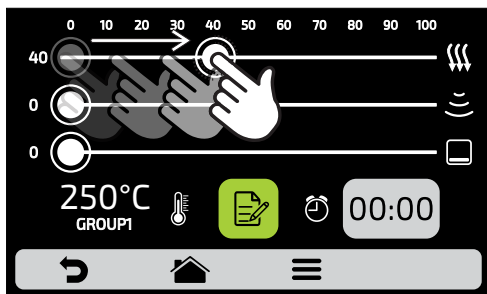

c) To change the impinged air speed, microwaves and bottom heating element wattage, just swipe the finger over the bar of each parameter or click on the desired location.

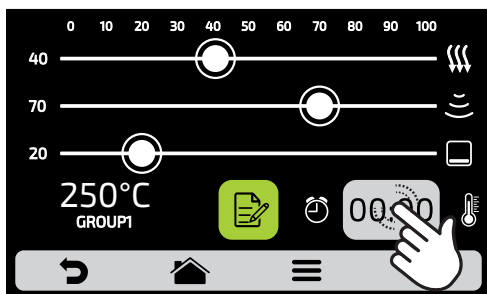

d) To set the time, click on the icon **00:00** . A keyboard will appear on the opposite side, et the desired value and click on ✓.

e) To define the temperature click on the icon **250°C GROUP1** . A keyboard will appear on the opposite side, set the desired value and click on ✓.



f) Click on the button  to access the options for edition of the step parameters, which are:



g) **Add Information**, which will be displayed at the end of the step during the execution of the recipe. Click on the icon .

h) **Enable and disable the step:**

- *The recipe only executes active steps. When a step is deactivated, it is not deleted, it only remains hidden.*
- *To delete the step, it is necessary to inform the 00:00 value to the time parameter.*



ACTIVE



INACTIVE

i) After concluding the edition of a step, use  to save and return to the steps screen to edit, create new step, or test the active steps.

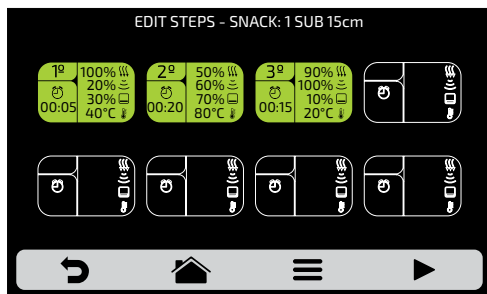

j) To test, click on the icon ▶ that is found in the fixed bar on the steps screen. Before proceeding with the test, make sure that there is food inside the chamber.

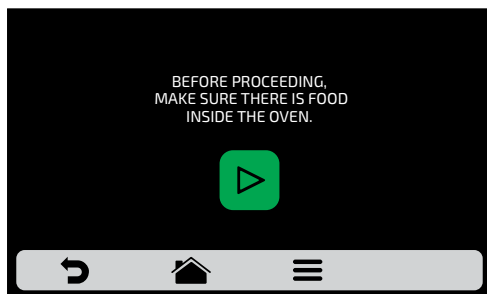

k) Use ↶ to return to the recipe editing options.

## DELETING RECIPE

a) Press 🗑️ to delete the recipe, press the button 🗑️ to confirm the exclusion or ↶ to return to the options for recipe edition.

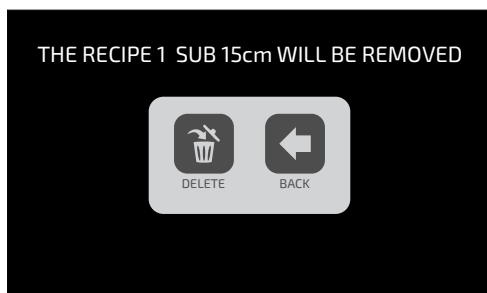

## ORDER

a) The Order function , allow to change the sequence in which the groups will appear on the groups screen.

*This screen is composed by three buttons:*

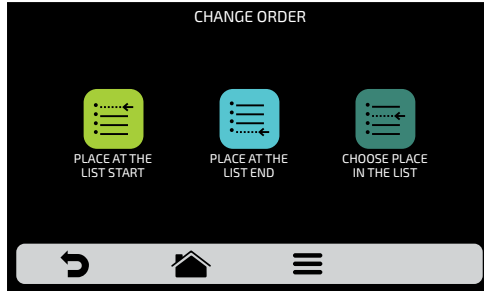



**Place at the list start:** The recipe is moved to the beginning of the groups list.



**Place at the list end:** The recipe is moved to the end of the groups list.



**Choose place in the list:** The operator will be directed to the groups screen to choose the location desired.

b) To change the position of a recipe, just press on the recipe to select and slide  to the desired position. Press  to save the change.

c) If the substitution is done vertically (1-2, 3-4, 5-6 and 7-8) the two recipes in question will change position without changing the order of the other recipes, as shown in the image below:

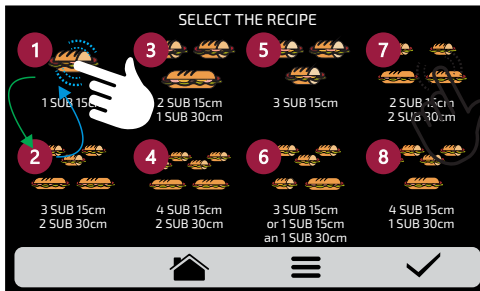



d) If the substitution is done randomly, once the position is selected, the recipes will be ordered sequentially (1, 2, 3, 4, 5, 6, 7 and 8), as shown in the image below:

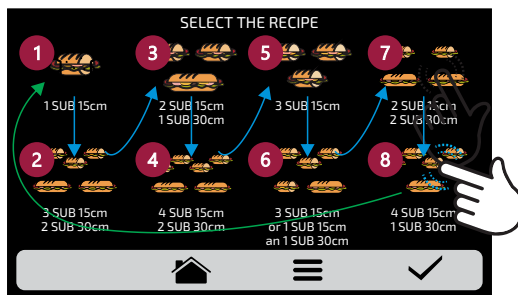

b) Use ↶ to return to the recipe editing options.

## EDIT COOK / BROWN MORE

a) The Cook/Brown More function is defined by recipe, that is, it is not a fixed value for all of them, the user may set the time he/she wishes for each one of the options.



Remember that:

- **Brown More** - Only activates *HOT AIR*.
- **Cook More** - Activates only the *MICROWAVE*.
- **Cook/Brown More** - Merges both elements.

b) To set the time, just click on the value location, as the indications on the screen show.



c) Use the numeric pad to inform the time and click on ✓ .

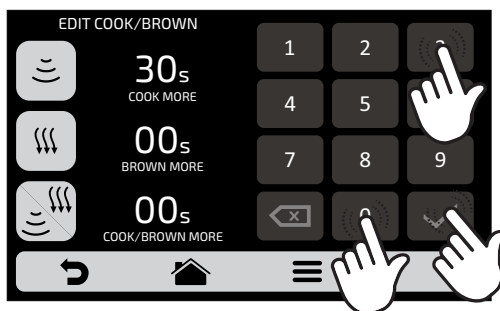

d) The Cook/Brown More function may be disabled in the Settings of Edit Access (see page 64).



e) Use ↶ to return to the recipe editing options.

## ADD / REMOVE FROM FAVORITES

a) The Favorites function may be accessed through the options screen in the fixed bar. However, it will be explained in detail on page 65.

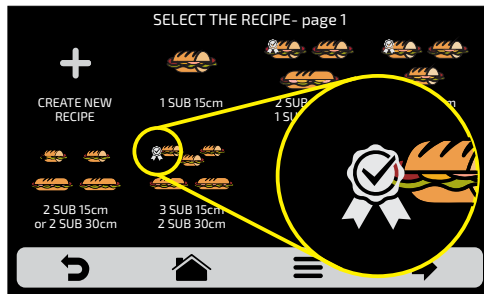
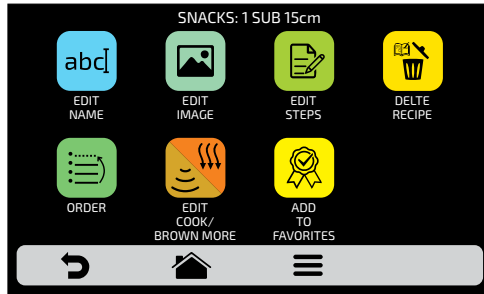
b) To add the recipe to the favorites, click on the icon 🍷 . A small label 🏆 will be added in the upper left corner of the recipe icon.



c) To remove the recipe from the favorites, just do the same process. In the recipe edition options screen, the Remove from Favorites icon will appear: , when clicking on it, the label  will disappear from the icon and the recipe will be removed from the Favorites list.

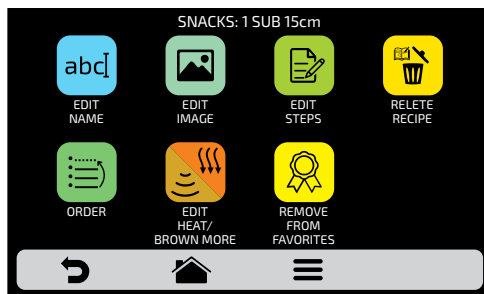



d) Use  to return to the previous screen.



## USER'S SETTINGS: PREHEAT

a) The editable parameters in Preheat are:

- *Temperature Preheat 1.*
- *Temperature Preheat 2.*
- *Preheat Time: Define the time of the stopwatch of the Preheating screen.*

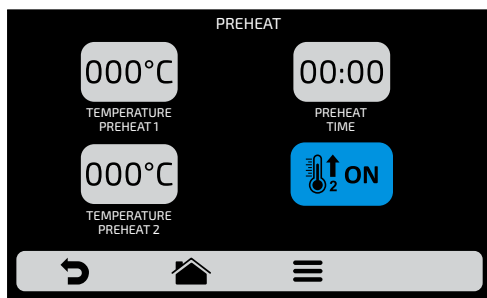
b) The  /  button enables/disables **Preheat 2**. When disabled, all settings related to Preheat 2 are hidden.



c) To edit the values, click on the icons  and  to change the value using the number pad beside.

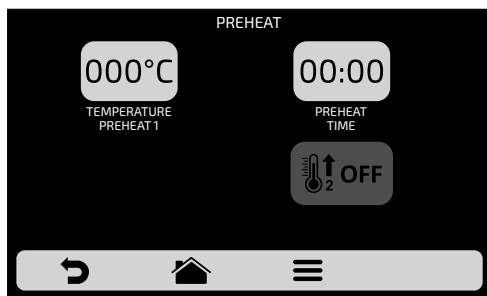

d) Use  to return to the user editing options.

## USER'S SETTINGS: USB

a) Press the button . The functions available in USB are: Import and Export.



b) When selecting one of the functions, the message: *“Insert the pen drive and wait for recognition”* will appear.

After the recognition, the user will be taken to the function options previously chosen:

- **Import:** All, Menus or Settings.
- **Export:** All, Menus or Settings.

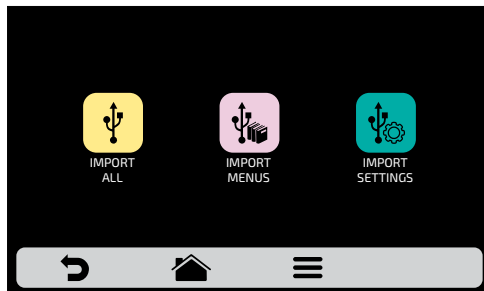

c) In case of error, the displayed message will be: *“There was an error during the Import/Export. Please remove USB disk and restart process.”*

d) Use  to return to the user editing options.

## ACCESS TO THE USB PORT

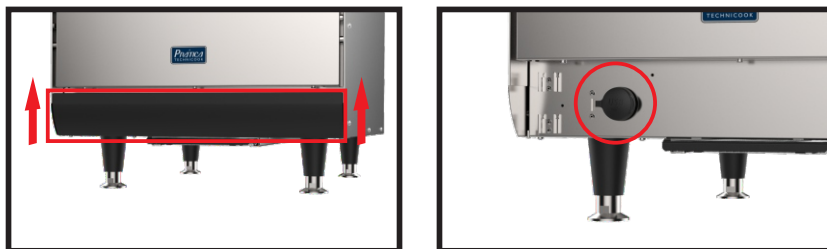

## USER'S SETTINGS: CURRENT TEMPERATURE

a) The **Current Temperature screen**  : is only informative. In this screen, it is possible to verify the temperature of top and bottom heating elements.

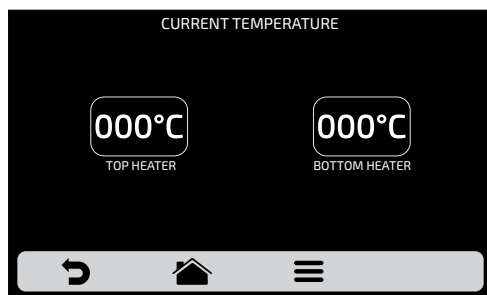

b) Use  to return to the user editing options.

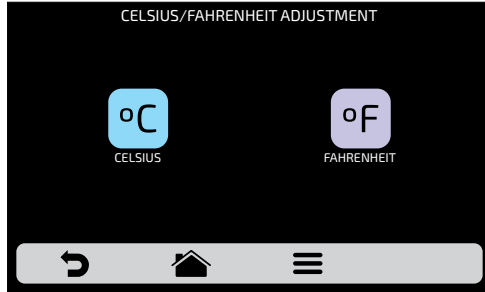

## USER'S SETTINGS: CELSIUS/FAHRENHEIT

a) Change the temperature format displayed in the oven between Celsius and Fahrenheit, Click on the icon  among the User's Settings, and set the temperature format you wish.



b) Use  to return to the user editing options.

## WI-FI

a) If you want to connect to a new wi-fi network, press the button  to view the available networks. Use the gridview, sliding  on the touch screen to see all networks.

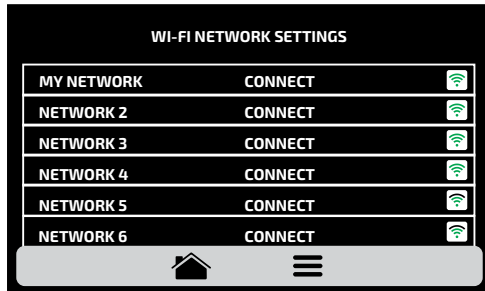

b) Click on the network you want to connect and then click on "ENTER PASSWORD":

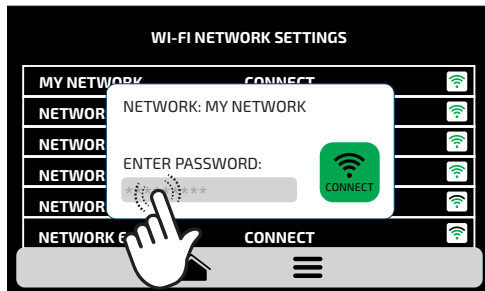

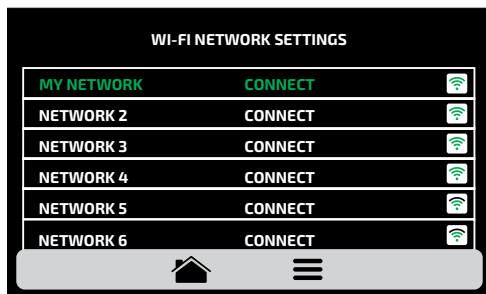

c) Use the alpha numeric keypad to enter the password and after finished press the button .

*The following screen shows the oven connected to the desired network:*

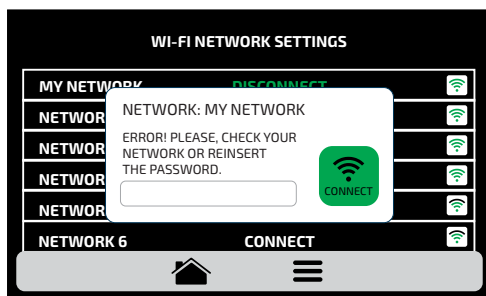

d) In case of incorrect password the following message will appear on the screen, make a new attempt:



**Note:** After selecting the Wi-Fi network for the first time, the preheating menu is automatically displayed. In the future, if the user wants to change network, he must do so through the WI-FI icon  in the settings menu.



## WEB APP (IOK - INTERNET OF KITCHEN)

a) Our Web App allows the user to create, edit and upload/download recipes.

b) Press the  icon to use the virtual platform. Access the platform to use the PIN CODE at: [new.praticaio.com](http://new.praticaio.com)

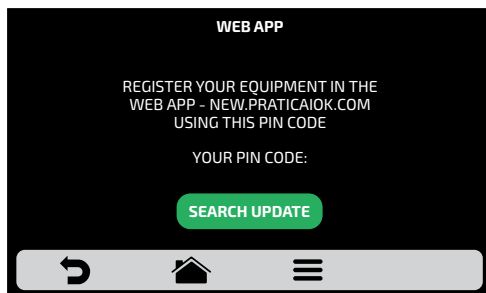

- All recipes created through the Web App can be sent directly to the oven. When submitted, just click on the  icon to update the oven recipes, as shown below:

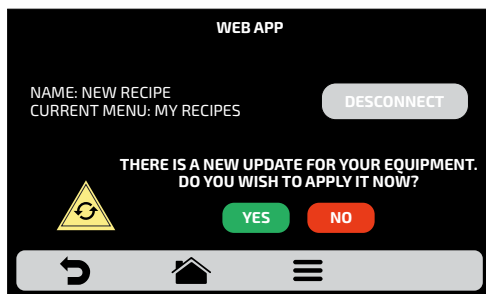

- **Wait for the update bar to be complete.**

c) When you are connected to **IOK**, the following screen will be shown:

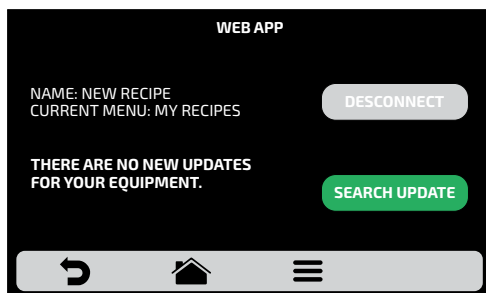

- **To disconnect from IOK press the  button.**

## SYSTEM UPDATE

a) Press the  button to choose how to update the system: .

**Note:** The  option should only be used by an authorized technician.

b) Then choose the Wi-fi option.

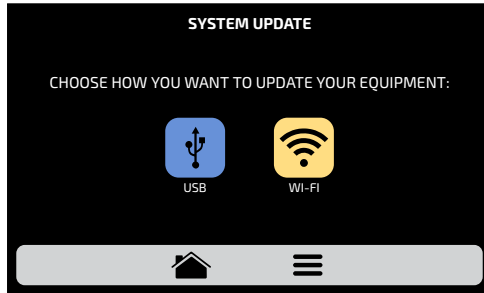

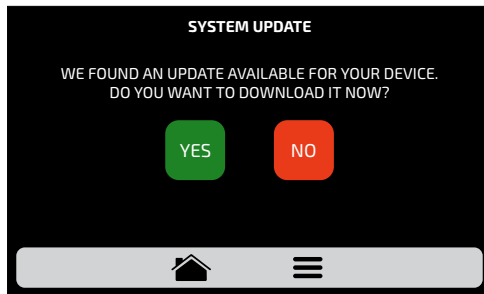

b) When a new update is available, the following screen will appear. Press the "Yes" icon to proceed with the update or "No" to return to the settings menu.



 The download is done in the background and the user returns to the previous screen.

 Returns to the settings menu.

c) While the download is being performed the green bar will blink, if you press the  icon, the download status screen will be displayed. By pressing the  icon, the previous screen will be displayed and the download will continue in the background.

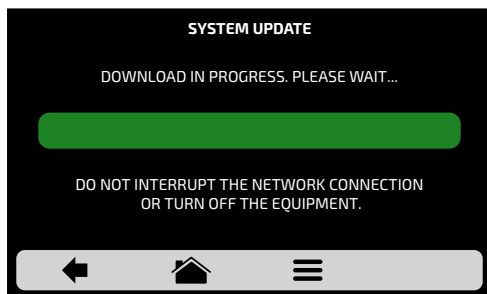

d) After the download is complete, it is necessary to restart your device.

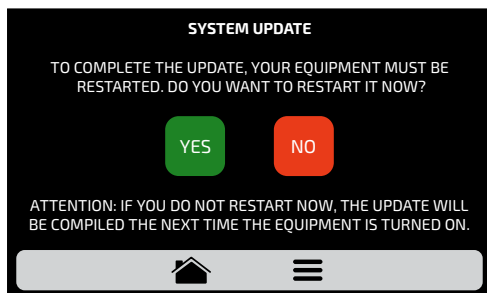

**Attention: If you do not restart at the moment, the update will be compiled the next time the equipment is turned on.**

**YES** Restarts the equipment.

**NO** Returns to the settings menu.

e) If you do not have an update available, the following message will be displayed on the screen:

*"There are currently no updates available for your device. When there is, the symbol below will be displayed in the upper right corner."*

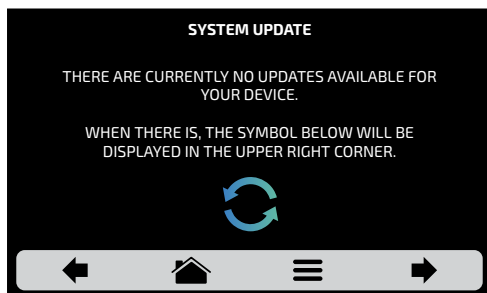

d) If an error occurs during the update, the following message will be displayed on the screen:

***“An error occurred while updating the system. Do you want to restart the process?”***

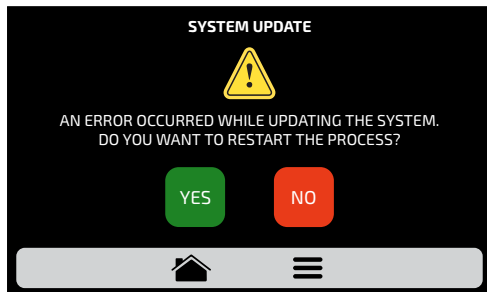

**YES** Restarts the equipment.

**NO** Returns to the settings menu.

## USER'S SETTINGS: CUSTOMER SUPPORT

a) In the Customer Support  information, you will find all the necessary data to contact Prática to clear out questions, request repairs or technical visits



b) Use  to return to the user editing options.

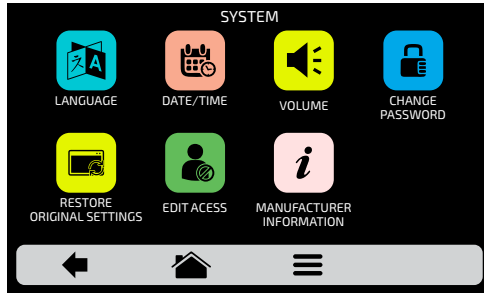

## USER'S SETTINGS: SYSTEM

a) The System  screen is composed by seven items. Understand each item in detail in the following pages.



b) Use  to return to the user editing options.

## SYSTEM: LANGUAGE

a) To change the language , just click on the icon and choose the desired language. We currently have the main languages around the world. Use the gridview, sliding  on the touch screen to see all languages.

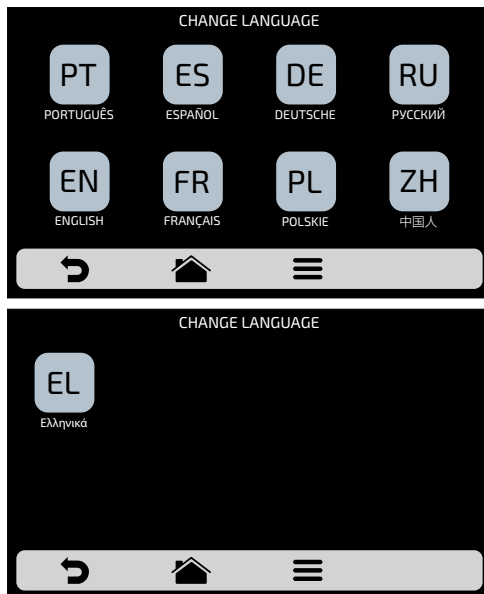



b) Use  to return to the user editing options.



## SYSTEM: DATE/TIME ADJUSTMENT

**Note:** If the oven is connected, it will automatically add all the information.

a) It is possible to adjust the Date, Time and format  it must be presented to the user, respecting the following standards:

**EUROPEAN:** DD/MM/YYYY      **TIME:** 24H FORMAT  
**AMERICAN:** MM/DD/YYYY      12H FORMAT  
**ISO:** YYYY/MM/DD

b) Click on  and  to edit, respectively, the date and time.

c) Press  to change the date/time format. The following screen will be displayed. Choose the date and time format and click on  to confirm and return to the options.

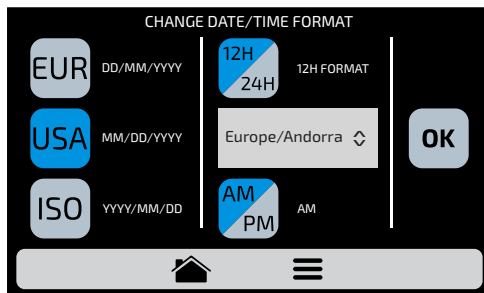
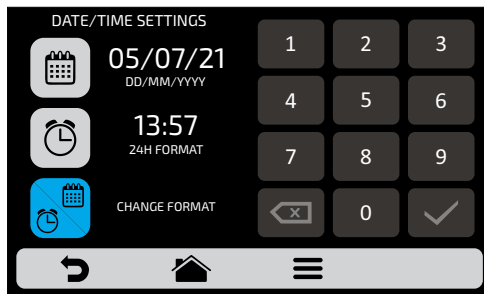

d) Use  to return to the user editing options.

## SYSTEM: VOLUME

a) In the volume screen  you can switch between 4 types of sound and also change the volume of the sound by sliding your finger on the screen.

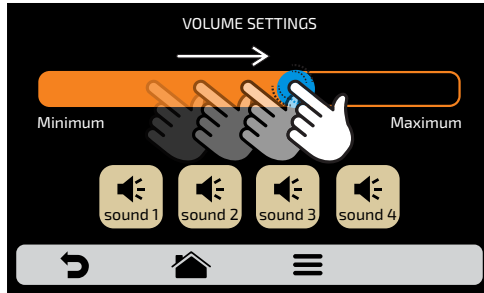

d) Use  to return to the user editing options.

## SYSTEM: CHANGE PASSWORD

a) To change the user's password , just type the new password and then confirm it just clicking on  .





b) In case you forget the password, contact Technical Support.

c) Use  to return to the user editing options.

## SYSTEM: RESTORE ORIGINAL SETTINGS

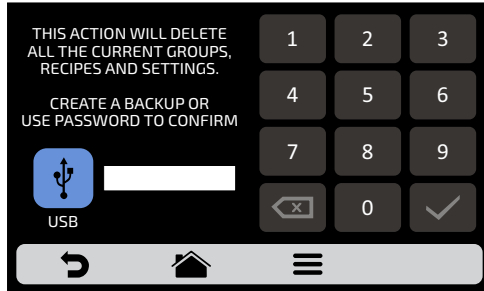
a) **ATTENTION:** The Restore Original Settings  option will delete all the Groups, Recipes and their Steps, besides the Settings defined by the user. Make sure to create a Backup through USB before proceeding. After inserting the password and touching **OK: IT IS NOT POSSIBLE TO RECOVER THE INFORMATION.**



b) Use  to return to the user editing options.

## SYSTEM: EDIT ACCESS

a) Edit Access  corresponds to the function in which you may block functions to the operator.

***For example:** If you desire that the Favorites and Manual Mode functions are never accessed by the operators, just click on both of them, which will turn dark gray, indicating that they are locked until the moment you desire to unlock them.*

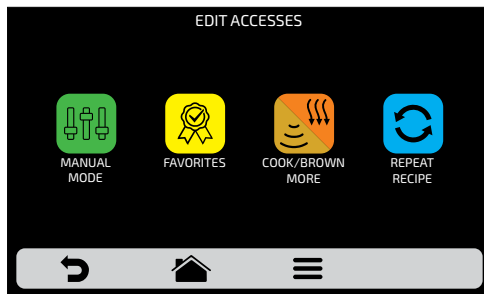

b) To unlock, just click on the desired functions once more.



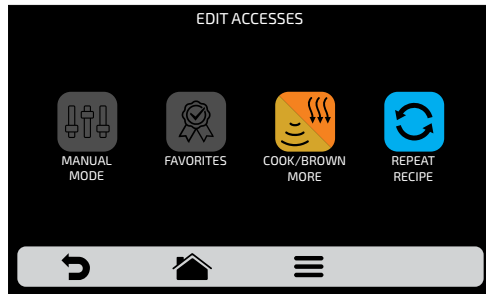



c) Use  to return to the user editing options.

## SYSTEM: MANUFACTURER'S INFORMATION

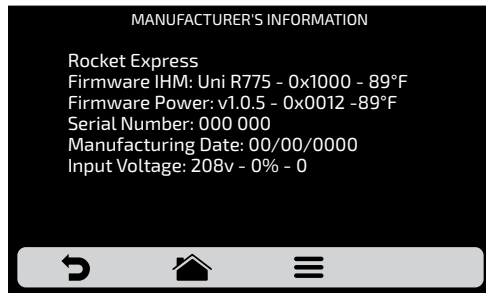
a) Information on Firmware Version, Serial and Manufacturing Date  of the **Rocket Express** are contained.



c) Use  to return to the user editing options.

## FAVORITES

a) The Favorites functionality works as a shortcut, in which you may allocate the main and most used recipes. To access it, just press the Options button  in the fixed menu bar.

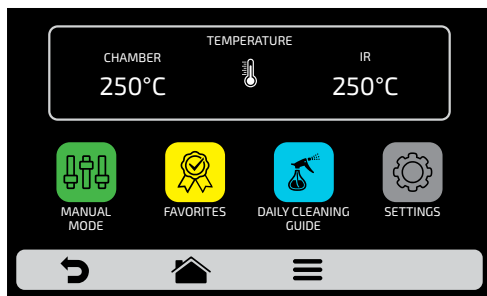

b) After opening the Options screen, touch the icon  .

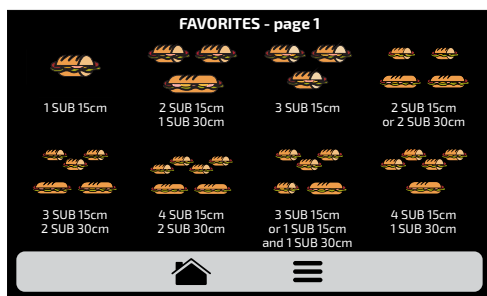

c) Browse through the recipes use the gridview, sliding  on the touch screen.

d) See how to Add or Remove a recipe from the Favorites list on **page 50**.

## SOUND ALARMS



- At the end of a recipe the alarm will sound indicating the end of the operation.





- If the oven door is open for more than 30s the alarm will sound alerting the user



- **Caution:** If the alarm signal sounds continuous, the equipment is malfunctioning. Turn off or disconnect from the power grid and check the instruction manual before operating.

## MANUAL MODE

a) In Manual Mode, it is possible to set the parameters of a recipe, execute it, and if the result of your test is approved, at the end of the operation, transform it in a recipe.

b) To access the Manual Mode, click on the Options icon . In the Options screen, touch the icon .

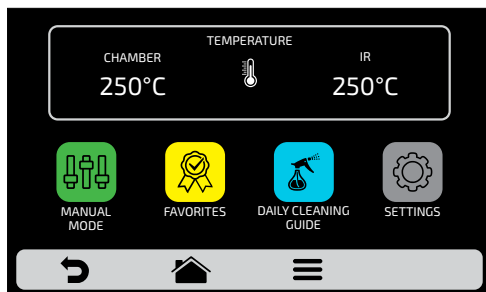

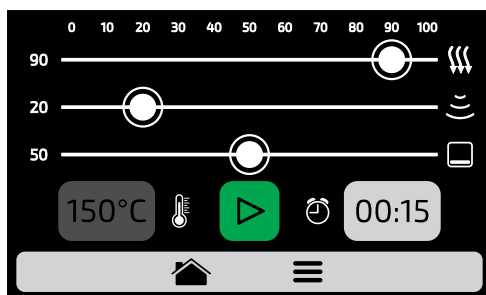

c) Set the parameters of Time, Temperature, Speed of Hot Air, Microwaves and bottom heating element (Infra-red).

d) Press the icon  to start the operation of Manual Mode.

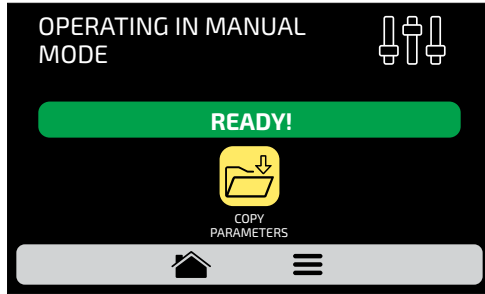

e) After the conclusion of the operation, the Copy Parameters icon will be enabled: .



f) Copy Parameters enables the user to transport the parameters set in Manual Mode for the Edition of Groups and Recipes, that is, by clicking on the icon  ,it will be necessary to inform the user's access password before.

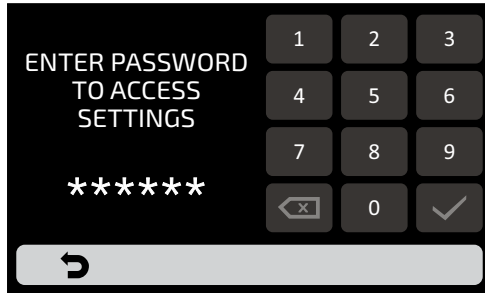

g) After informing the user's password, choose between creating a new group or allocating the transported parameters in a new recipe in an already existent group.

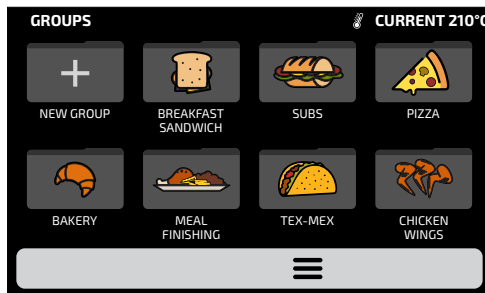

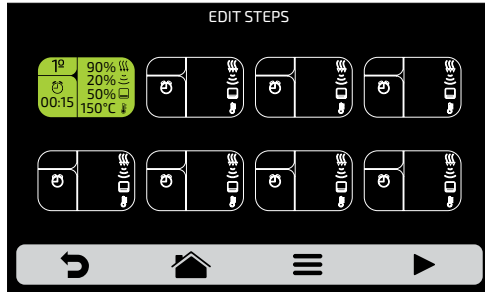

f) Set the name of the New Recipe, the Image and choose in which position (step) the user wishes to allocate the transported information.



g) To finish, if desired set the other steps of the recipe.

## CLEANING PROCEDURE GUIDE

a) To help in the sanitation of the **Rocket Express**, use the Cleaning Procedure Guide, accessing it through the Options screen, then clicking on the Options icon  , and then pressing the button  , follow the steps informed on the screen carefully.

b) At each step it is possible to watch a video that teaches the user how to perform the cleaning by pressing the  icon on the screen.

1<sup>st</sup>: Open the door and wait for the temperature to get down to 122°F. Proceed clicking on the arrow: 

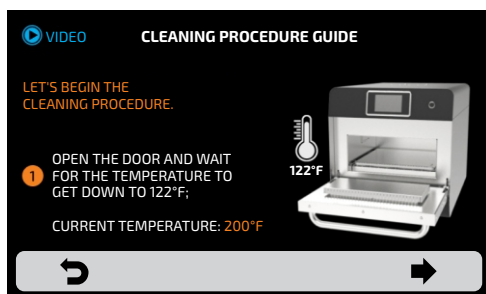

2<sup>nd</sup>: Remove the rack, the back of the oven chamber and the catalytic and place them on the sink. Proceed clicking on the arrow: 

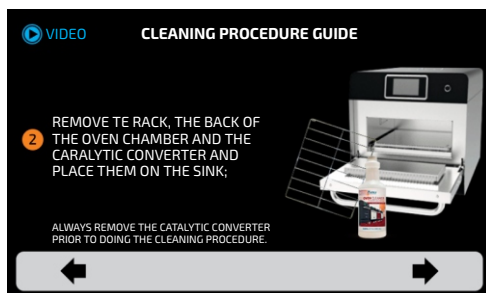

3<sup>rd</sup>: 1/2 - Apply the Oven Cleaner on the rack and the back of the oven chamber and leave it for 2 minutes before the next step. Proceed clicking on the arrow: ➡

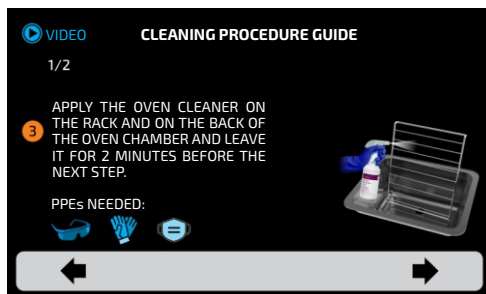

3<sup>rd</sup>: 2/2 - To wash the catalytic converter place it in a container with water and soap and let it soak. Proceed clicking on the arrow: ➡

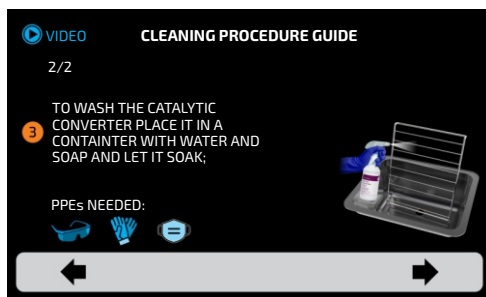

**Note: After the oven has cooled down and before applying the Oven Cleaner, wipe the chamber surfaces with a damp cloth to lower the temperature.**

4<sup>th</sup>: Apply the oven cleaner in the chamber walls and the inside of the door. press the ▶ icon to start de timer and leave it for 5 minutes. Proceed clicking on the arrow: ➡

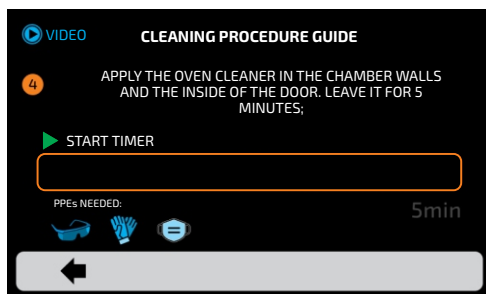

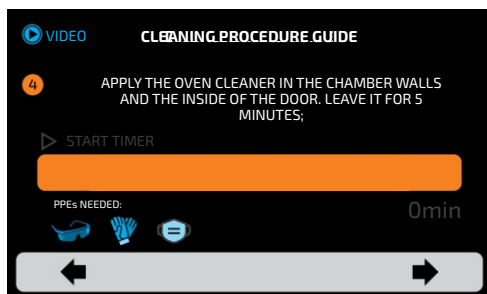

*At the end of the 5 minutes the alarm will sound and releases the screen advance*

**5<sup>th</sup>:** Use a non-scratch sponge to clean all the cooking chamber and the glasses of the wave guides. Proceed clicking on the arrow: ➡

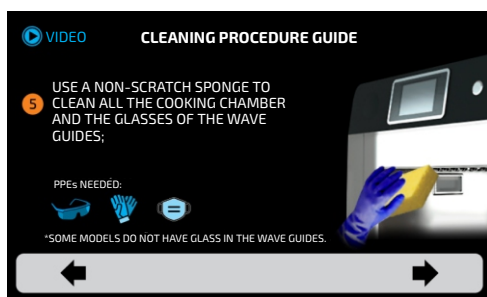

**6<sup>th</sup>:** Clean/Rinse the chamber with a wet tissue to remove the excess and dry it with a new, clean tissue. Proceed clicking on the arrow: ➡





7<sup>th</sup>-1/2: Always use a non-scratch sponge to scrub any persistent dirty in the rack and back of the oven chamber. Proceed clicking on the arrow: ➡

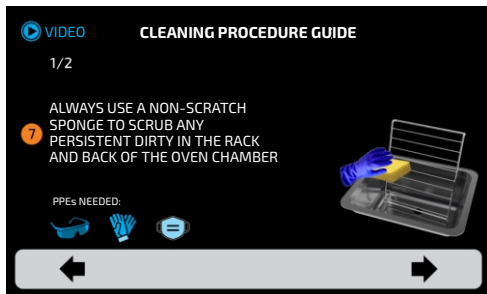

7<sup>th</sup>-2/2: Rinse the rack, and the catalytic converter after applying cleaner or after soaking it in soap water. Proceed clicking on the arrow: ➡

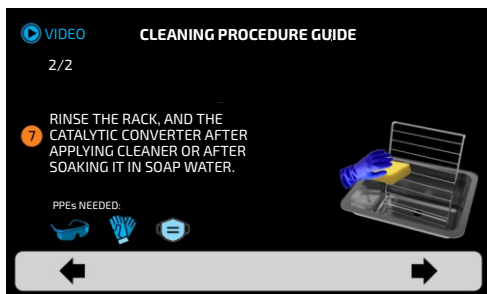

8<sup>th</sup>: Put back the catalytic converter, the back of the oven chamber and the rack. make sure it fits correctly. Finish by clicking the arrow: ➡



## CATALYTIC CONVERTER CLEANING GUIDE

- a) To have access to catalytic converter, remove the stone, the grill and removable lower tray from the oven.
- b) Then, remove the catalytic converter with an upward movement, as in the image.
- c) Inspect the converter, shake to remove any loose particles and rinse with water. If necessary, to remove stubborn debris, apply Pratica Oven Cleaner, allow to set for 10 minutes, then rinse with water.
- d) Before installing back the converter to the oven, remove any water excess. If necessary, shake or tap on a hard surface to confirm.

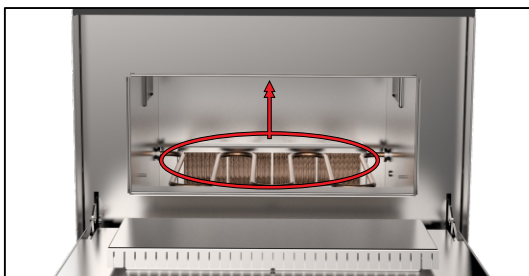

## AIR FILTER CLEANING GUIDE

- a) Access the Cavity Air Filter from the oven bottom.
- b) Pull the filter forward to remove it.
- c) Inspect and clean if necessary, with neutral detergents and water.
- d) Rinse well with clean water and remove any excess water. If necessary, shake or tap on a hard surface to confirm.
- e) Install back the filter to its position.

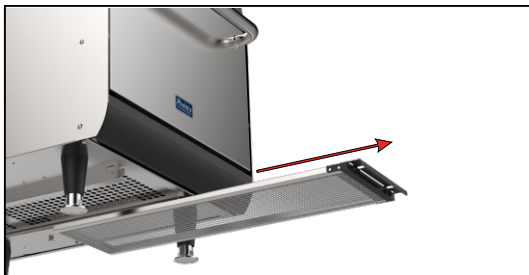

## ALERTS AND ERRORS: POSSIBLE SOLUTIONS

a) The **Rocket Express** is programmed to signal any possible error and alerts that may occur during the operation.

b) On the Options icon ☰ , a yellow signal will appear for alerts (⚠️) and red for errors (🚫).

c) See how to proceed in each case below:

### ⚠️ ALERTS

a) Click on the Options icon ☰ .

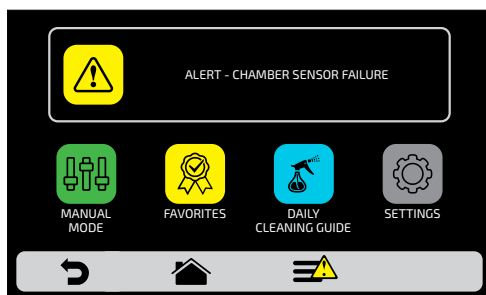

b) The Options screen will bring, instead of the top and bottom heaters temperatures, a description of the alert. In the adjacent example:

### ALERT - CHAMBER SENSOR FAILURE

c) Follow the orientation as described on the screen. In this case, turn off and turn on the oven again using the panel button:



**Note:** If you press the power button the following message will be shown on the screen:

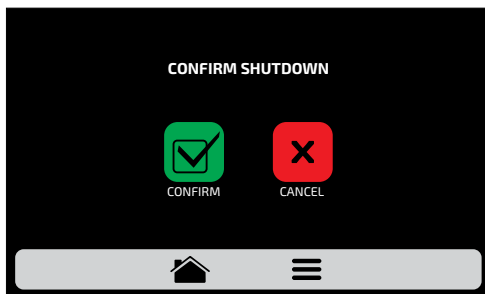

**Note:** Or press the power button for 3 seconds to power off directly.

d) After turn on the equipment, if the fault persists, call the Technical Service.



## ERRORS

a) In case of several unsuccessful reset attempts, the alert will become an error, and it will be necessary to contact Technical Support.

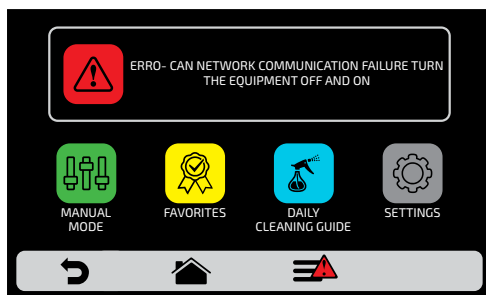

b) Refer to the table on the next screen to verify the possible errors and alerts.

## ALERTS AND ERRORS TABLE

Component	Becomes Alert when:	Becomes Error when:	Error Sound Alarm
Inverter	lost communication	-	Off
Inverter	-	more than ten reset attempts	On
CLMG Low Magnetron Current	fifteen seconds without reaching the standard performance.	-	On
Can Network Communication	-	cables disconnected or faulty	On
Chamber Sensor and IR	only one inactive	both inactive	On
Panel temperature	from 65 °C to 80 °C	exceeding 80 °C for 10 minutes	On

*You can call our technical assistance to provide feedback, offer suggestions, or get technical assistance during normal business hours at: **+55 35 3449-1235 (All world) or 214-584-6269 (Only for United States and Canada).***

**ROCKET EXPRESS**  
**CODE:742609**  
INSTALLATION AND OPERATIONAL MANUAL  
APRIL 2022 - REVISION 02





# *PRÁTICA*

**PRÁTICA PRODUCTS, INC.  
USA**

424 East Church Street  
Lewisville, TX 75057  
Phone: +1 214 584-6269  
[www.praticausa.com](http://www.praticausa.com)  
[info@praticausa.com](mailto:info@praticausa.com)

---

**PRÁTICA KLIMAQUIP IND. E COM. S.A  
BRAZIL**

Rodovia BR 459, Km 101 S/N  
37.556-140, Pouso Alegre - MG  
Telefone: +55 35 3449-1235  
[pratica@praticabr.com](mailto:pratica@praticabr.com)